



Installation and Operation Manual

FD320CV VER HD

32" High-Definition Widescreen LCD

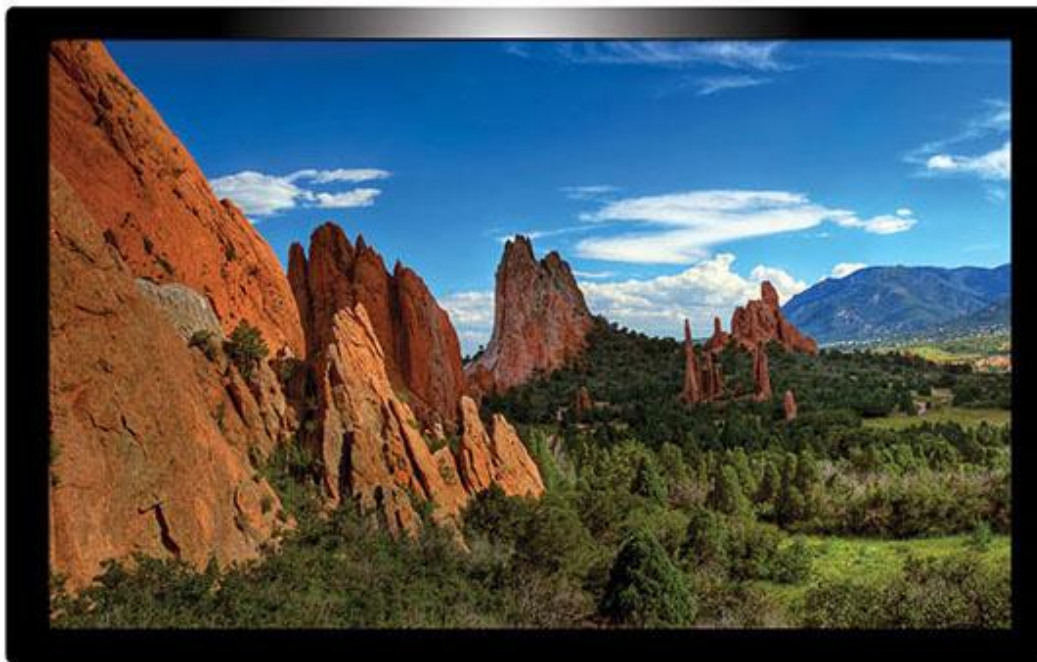



Table of Contents

General Information	3
Front View	3
Additional Information	3
Specifications	4
Installation Instructions	4
Rear Connector Orientation	5
Power.....	5
Wiring Instructions.....	6
S-Video/Composite and Audio Wiring	6
VGA Wiring	7
RS-485 Wiring	7
HDMI	8
Power & Ground Wiring	9
Power/Video.....	10
Command Sets for Controlling the Monitor	11
Command Sets for Controlling the Monitor	12
RS-485 Network	13
Operations Instructions	14
Button Control	14
Remote Control Buttons	15
Technical Drawings.....	16
Technical Drawings.....	17
Technical Support	18
Instructions for Continued Airworthiness.....	18
Limited Warranty	19
Log of Revisions	20



General Information

The FD320CV VER HD is a 32" High-Definition Widescreen LCD which has features that allow installation in the smallest of mounting areas with the minimum of interface equipment. Built with retrofit aircraft integration in mind, this display can switch between five video input sources using an infrared remote.

Front View

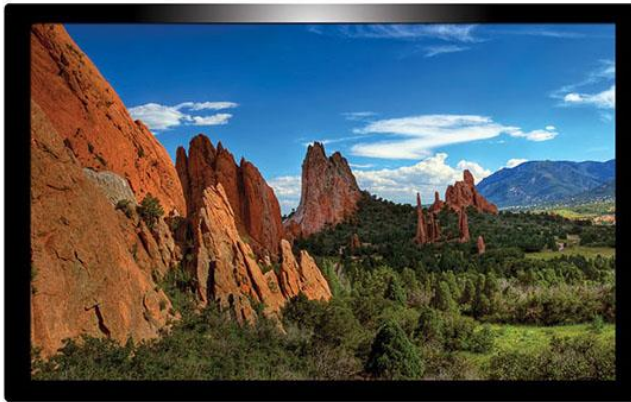

Additional Information

The FD320CV VER HD utilizes a state of the art digital video decoding chipset for the analog video input. There are FIVE video source inputs available. They are in order of picture quality: (2) HDMI (Hi-Def video, such as Blu-Ray DVD or PlayStation 3), (1) VGA (computer graphics like Moving Maps), (1) S-Video and (1) Composite Video (DVD, camera or VCR). Both NTSC and PAL formats are auto-detected.

The FD320CV VER HD can also be connected to existing video switchers and use only a composite video input from a selector interface box. In this case, the IR remote will only be used to set up the screen after installation. E.g. adjust brightness, contrast, etc.

The LCD is protected with a .125" Lexan lens. The purpose of this lens is to prevent scratching of the LCD and reduce glare. The FD320CV VER HD is made of all metal components. DO-160 testing has been completed and is available upon request.

Specifications

Display Type	32" TFT Color LCD
Display Color	16.7 Million Colors
Screen Resolution	1600x1200 UXGA
Brightness	500 cd/m ²
Dimensions	31.00" (W) x 18.70" (H) x 2.55" (D)
Display Size	31.51" (800mm) diagonal
Weight	27.3 lbs.
Power	28VDC @ 6.6Amps
PC & Video Input	VGA (High Density DB-15 Connector), S-Video, Composite, HDMI (2)
Video Type Supported	NTSC/PAL
Screen Control	On Screen Display Menu
Viewing Angle	178° on Both Axis
Materials	Aluminum
DO-160 Testing	Section 21, Category B
Remote Control	IR, included
Pixel Pitch	170.5 x 510.5

Installation Instructions

All cabin entertainment equipment, such as the FD320CV VER HD, should be installed on a non-essential bus and have a dedicated circuit breaker. It is a requirement that a switch be installed in the cockpit so that the pilot can de-energize the entertainment system should it become necessary.

There are twelve 10-32 UNF mounting holes located on the sides and back of the display. Eight holes are located at the four corners and centre of the back and four holes are located two on each side of the bezel. It is sufficient to mount the display by six attach points.

Mounting against the bulkhead or on a bracket: The unit can be mounted internal, external, or partially internal to the bulkhead. It is recommended that you leave about ¼ inch of space around the rear, top and bottom of the display for the exhaust fan to have circulating air. When mounting from inside the bulkhead it is possible to have only the LCD visible to the cabin. The unit will come on automatically upon power application and if using an external video source selection box the IR is not needed. If you are using the IR to change the video source selection, then you need to have the IR LED visible to the cabin.

Rear Connector Orientation

The rear connector of this monitor can be mounted horizontally (connector perpendicular to rear of monitor) or vertically (connector perpendicular to bottom of monitor) in order to give you the most convenient mounting options. By default, this monitor's connector ships in the rear/horizontal position. FDS Avionics Corp will ship the unit with the optional bottom/vertical mounting connector configuration if specified at the time of order; contact your local sales representative for assistance. It is possible to change the connector orientation at the time of installation. For instructions on how to change the connector orientation please call FDS Avionics Corp at **+1 (470) 239-7421** and ask for Technical Support.

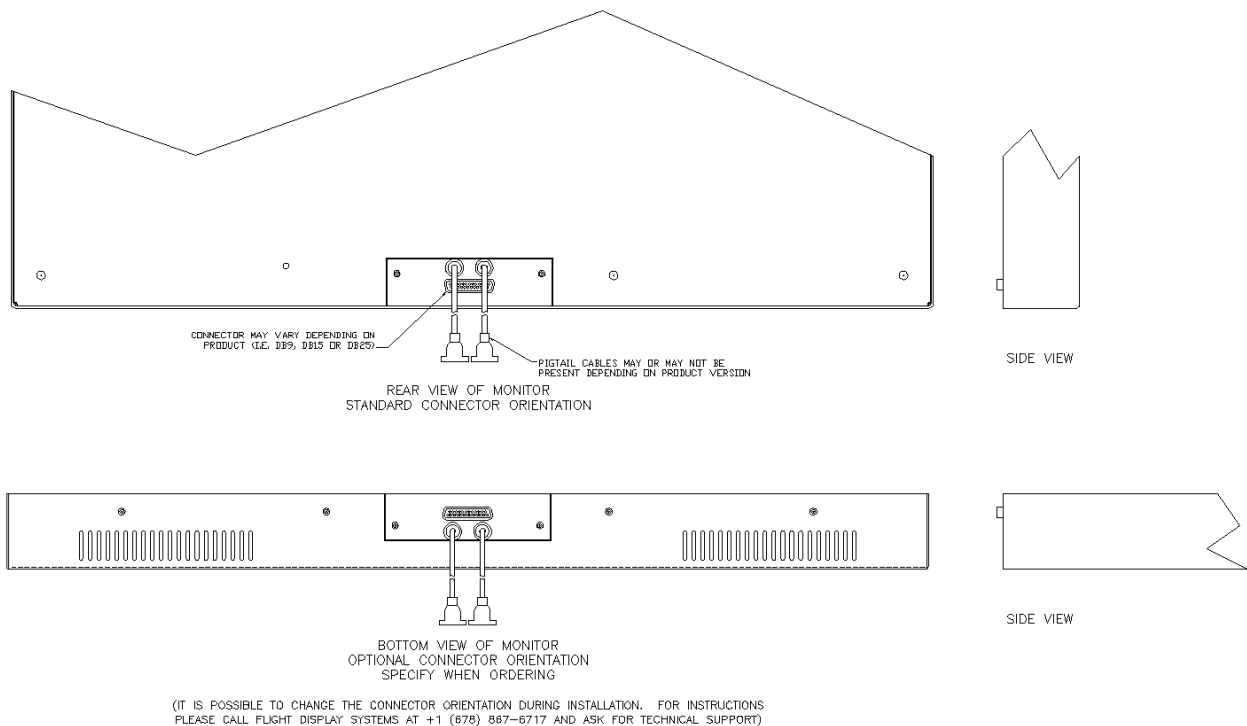

Power

This is a 28VDC monitor that requires 6.6Amps of power to operate. The unit turns on automatically upon power application.

Wiring Suggestions

All shields should be grounded to the connector at the source, and floating at the display.

Avoid routing video wiring parallel to:

- AC wiring
- Strobe wiring
- DC motor supply cables
- Inverter cabling
- Or any other potential noise source.

S-Video/Composite and Audio Wiring

Recommended cable for s-video/composite and audio purposes is PIC 75 Ohm Coax, P/N V76261. This is a lightweight, flexible, and low signal loss cable which meets FAA flammability requirements of FAR 23.1359(d), FAR 25.853(a) and FAR 25.869(a)(4).

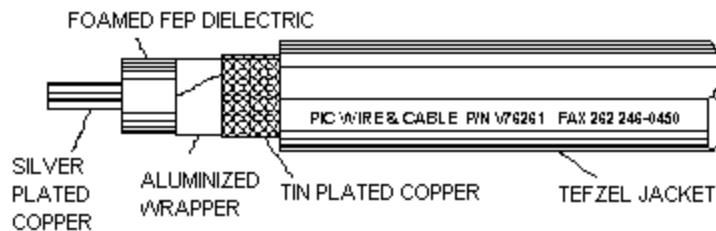

Similar aviation coaxial cable can be used from other vendors, as well.

Some aircraft are prone to AC noise - we recommend adding to the composite source a 75 Ohm video isolation transformer such as Deerfield Laboratory, Inc. Part No. 162-1 (www.deerfieldlab.com, (650) 632-4090). In most cases this should be added to the video output of the source.

We recommend coax cables be terminated using solder sleeve coaxial cable terminators such as Raychem Part Number CWT-4174-W122-5/9.

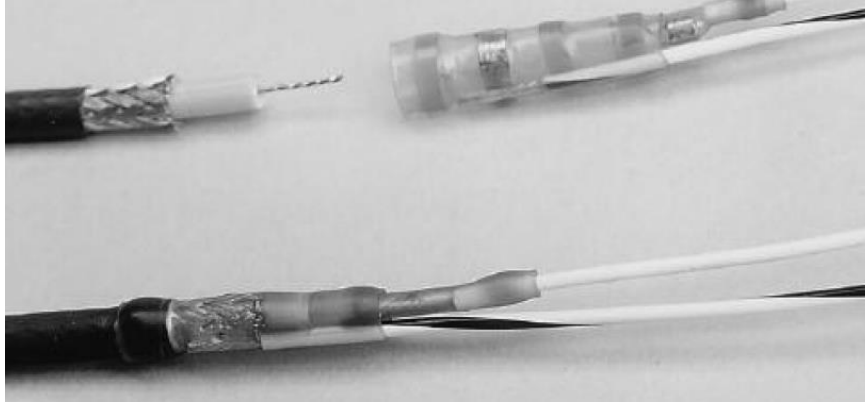

VGA Wiring

Recommended cable for VGA purpose is ECS P/N 453005. This is a single shielded cable containing 5 separate coaxial cables, color-coded to match the functions of the wires.

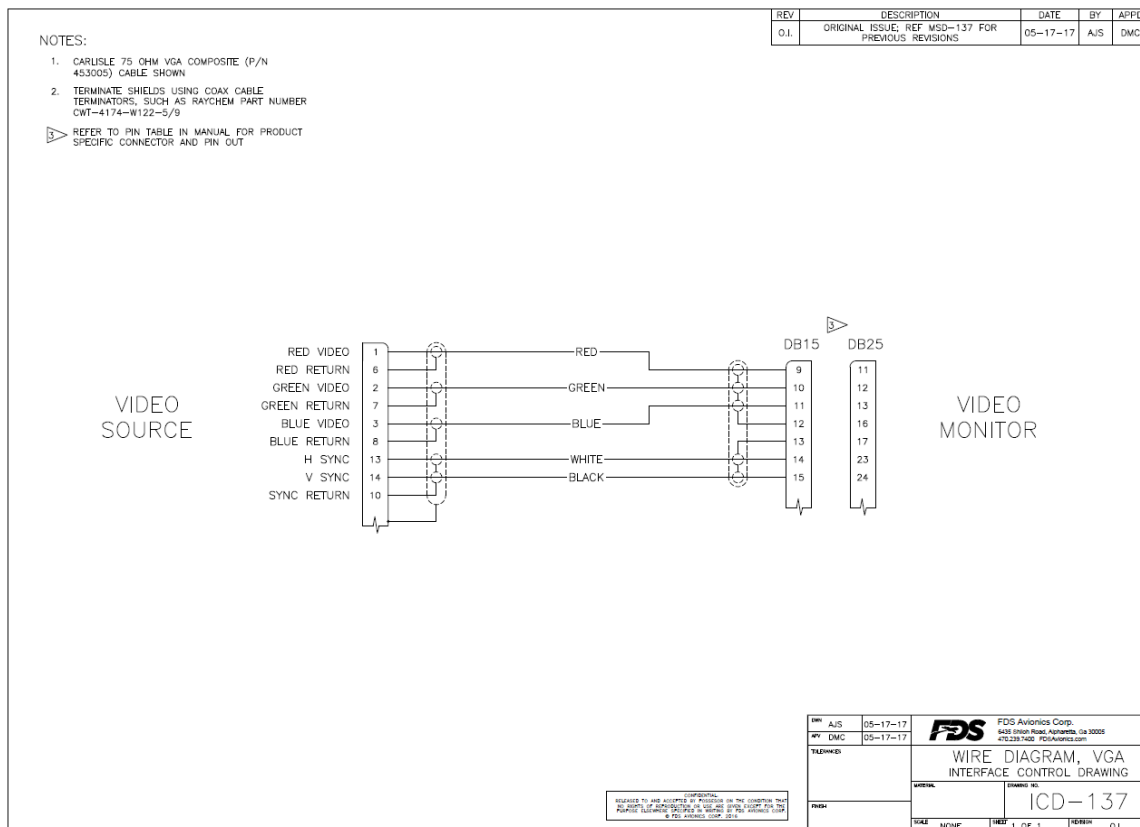

RS-485 Wiring

Shielded twisted-pair 22 AWG wire is recommended for RS-485 wiring.

HDMI

HDMI (High-Definition Multimedia Interface) defines the protocol and electrical specifications for the signalling, pin-out, electrical, and mechanical requirements of cable and connectors used for transmitting High-Definition content. The Type A HDMI connector (shown below) has 19 pins with bandwidth to support all SDTV, EDTV, and HDTV modes. The plug's outside dimensions are 13.9 mm wide by 4.45 mm high.

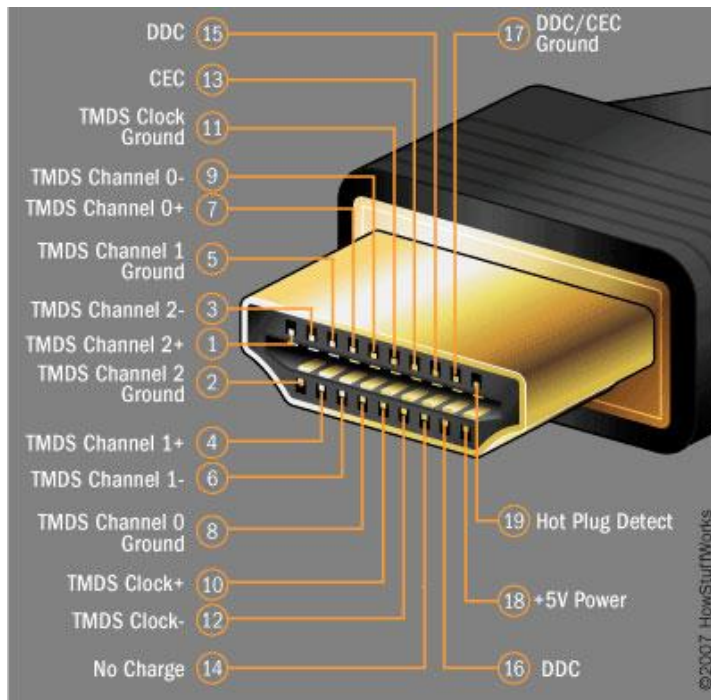

ECS manufactures an HDMI cable that is terminated at the factory. It is ordered as part number 600-19786-XXX, where XXX is the length in inches for the desired cable.

Power and Ground Wiring

This is a 28VDC monitor that requires 6.6 Amps of power to operate. The rated current of the equipment and associated voltage drop should be taken into consideration when selecting wire gauge. To operate properly this monitor requires an input voltage of 25-32VDC allowing a 3 volt drop on the wire, this is equal to the sum of the voltage drop on the 28V power wire and the voltage drop on the ground or power return wire.

The following examples are based on an install with a 28VDC power system and a total of 50 feet of wire between the circuit breaker, monitor and ground.

Example 1: 20awg wire has 9.88 Ohms per 1000 feet, this equates to .494 Ohms for 50 feet. 6.6 Amps of current on .494 Ohms will drop 3.26 Volts. This exceeds the allowable voltage drop to operate this monitor.

Example 2: 10awg wire has 1.26 Ohms per 1000 feet, this equates to .063 Ohms for 50 feet. 6.6 Amps of current on .063 Ohms will drop 0.42 Volts. This is within the allowable range to operate this monitor.

Resistance of Wire Type M22759/16-** (** = Gauge)	
Gauge (AWG)	OHMS/1000'
24	26.20
22	16.20
20	9.88
16	4.81
12	2.02
10	1.26
8	.701

Some connector pins are only compatible with the smaller gauge wires. If multiple power pins are available then all pins should be used. Multiple strands of wire may be run to the circuit breaker panel, or the multiple small gauge wires may be joined to a larger gauge wire for a single strand run to the circuit breaker panel. Also, use short heavy gauge wire and a clean tight connection for ground.

It is the installer's responsibility to understand the product's requirements to install the product in compliance with industry standards and safety.

Power/Video

Pin out for DB-25 Receptacle

Connector
 Crimp Contacts

P/N: M24308/2-283 or Equivalent
 P/N: M39029/63-368 or Equivalent

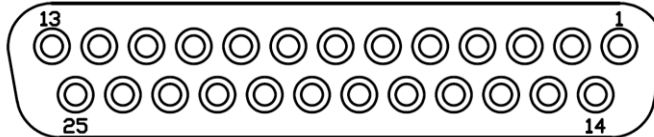

MATING FACE

Pin Number	Description
1	28VDC Power
2	28VDC Ground
3	28VDC Power
4	28VDC Ground
5	Composite Video – Signal
6	Composite Video – Shield
7	S-Video Y – Signal
8	S-Video Y – Shield
9	S-Video C – Signal
10	S-Video C – Shield
11	Red Video (Pin 1 on Standard VGA)
12	Green Video (Pin 2 on Standard VGA)
13	Blue Video (Pin 3 on Standard VGA)
14	28VDC Power
15	28VDC Ground
16	Red Ground (Pin 6 on Standard VGA)
17	Green Ground (Pin 7 on Standard VGA)
18	N/C
19	N/C
20	RS-485 Input A
21	RS-485 Input B
22	N/C
23	Horizontal Sync (Pin 13 on Standard VGA)
24	Vertical Sync (Pin 14 on Standard VGA)
25	N/C



Command sets for controlling the monitors with serial numbers starting w/ 11XXXXXXXX (10 digits) and below:

Below are the command sets to control the power, source selection, and backlight brightness. The 13 characters below are shown in hexadecimal. The communication system must be set up for 19200 Baud, no parity, 8 bits of data, and 1 stop bit.

POWER						
POWER OFF	0xBE 0xEF 0x02 0x06 0x00 0x1F 0xD1 0x26 0x00	0x00	0x00	0x01	0x00	CR
POWER ON	0xBE 0xEF 0x02 0x06 0x00 0x1F 0xD1 0x26 0x00	0x00	0x01	0x01	0x00	CR
SOURCE SELECTION						
VGA	0xBE 0xEF 0x02 0x06 0x00 0x1F 0xD1 0x26 0x00	0x00	0x00	0x02	0x00	CR
Composite	0xBE 0xEF 0x02 0x06 0x00 0x1F 0xD1 0x26 0x00	0x00	0x01	0x02	0x00	CR
S-Video	0xBE 0xEF 0x02 0x06 0x00 0x1F 0xD1 0x26 0x00	0x00	0x02	0x02	0x00	CR
HDMI 1	0xBE 0xEF 0x02 0x06 0x00 0x1F 0xD1 0x26 0x00	0x00	0x06	0x02	0x00	CR
HDMI 2	0xBE 0xEF 0x02 0x06 0x00 0x1F 0xD1 0x26 0x00	0x00	0x07	0x02	0x00	CR
BACKLIGHT						
0%	0xBE 0xEF 0x02 0x06 0x00 0x1F 0xD1 0x26 0x00	0x00	0x00	0x03	0x00	CR
Increment by 1%	0xBE 0xEF 0x02 0x06 0x00 0x1F 0xD1 0x26 0x00	0x00	Increment by 0x01	0x03	0x00	CR
100%	0xBE 0xEF 0x02 0x06 0x00 0x1F 0xD1 0x26 0x00	0x00	0x64	0x03	0x00	CR
Notes						
	1	2	3	4		5

Notes:

1. The first nine characters will remain the same for any command.
2. For connecting multiple monitors to one controller; the number can be set to 0x00 to control all monitors at once, 0x01 to control monitor number 1, 0x02 monitor number 2, and so on until 0x63 for monitor number 99.
3. The number will change depending on command.
4. Identifier for the group of commands.
5. All commands need to end with a Carriage Return





Command sets for controlling the monitors with serial numbers starting w/ 12XXXXXXXXX (10 digits) and above:

Commands								
	Length	CMD	Index		Set ID	Data		Check Sum
Power On	0x08	0x12	0x9C	0x00	0x00	0x01	0x01	0x48
Power Off	0x08	0x12	0x9C	0x00	0x00	0x00	0x01	0x49
HDMI 1	0x08	0x12	0x8E	0x00	0x00	0x00	0x01	0x57
HDMI 2	0x08	0x12	0x8E	0x00	0x00	0x01	0x01	0x56
DVI	0x08	0x12	0x8E	0x00	0x00	0x02	0x01	0x55
VGA	0x08	0x12	0x8E	0x00	0x00	0x03	0x01	0x54
S-Video	0x08	0x12	0x8E	0x00	0x00	0x04	0x01	0x53
Composite	0x08	0x12	0x8E	0x00	0x00	0x05	0x01	0x52
Auto	0x08	0x12	0x7E	0x00	0x00	0x00	0x01	0x67
Full Screen	0x08	0x12	0x7E	0x00	0x00	0x01	0x01	0x66
16:9	0x08	0x12	0x7E	0x00	0x00	0x02	0x01	0x65
4:3	0x08	0x12	0x7E	0x00	0x00	0x03	0x01	0x64
1:1	0x08	0x12	0x7E	0x00	0x00	0x04	0x01	0x63

The RS-485 connector carries information between the Infrared received and the LCD controller board. Any connections to the RS-485 bus must be tolerant to the existing control signals. Devices connected to the RS-485 Bus should not send traffic that interferes with the existing RS-485 messages.



RS-485 Network

If there is more than one monitor connected to the aircraft's RS-485 controller system, then it is strongly recommended to connect the system in series, or daisy-chain, and terminate the twisted pairs with a 120 OHM resistor. This configuration improves the reliability of the system.

It is highly recommended to use 22 AWG twisted pairs for runs longer than 20 feet. Connect all RS-485A pins together, all RS-485B pins together.

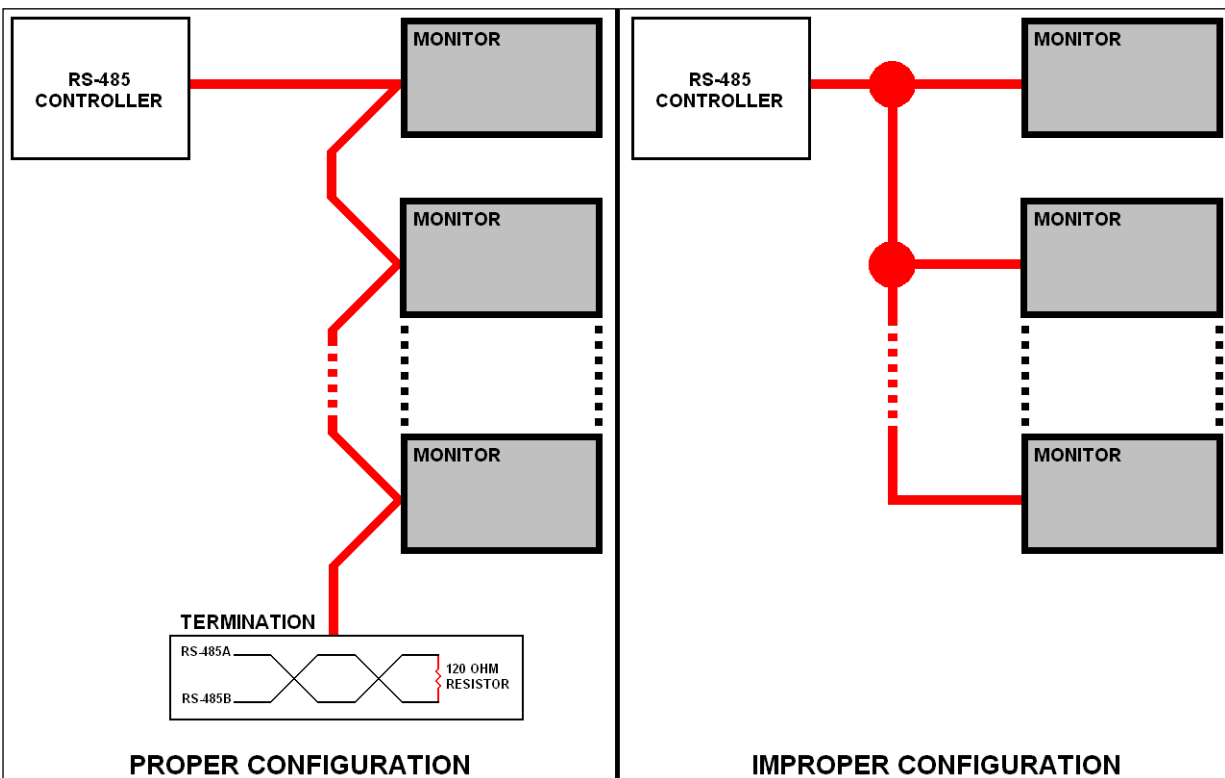

Setting ID Numbers for Multiple Monitors:

When two or more monitors are installed on the same RS-485 Network, an ID number must be assigned to each monitor. To assign an ID:

- Press the menu button (either on the monitor or remote control)
- Navigate to the "image" tab
- Navigate down to "set ID"
- Press left or right to assign a number to the monitor
- Press menu twice to exit

Operation Instructions

The FD320CV VER HD is continuously on but can be de-energized by removing power from the entertainment system. No pilot or aircrew action is necessary during flight or ground operation.

The passengers will be able to change the video output from the FD320CV VER HD using the video source button on the display, or remotely with the included IR remote. Point the IR remote at the top of the LCD to make changes.

When applying 28VDC power, the display will turn on and look for a valid input on the last known source. If no input is found, the display will go to standby mode. Pressing the Select button will select new video input.

Button Controls

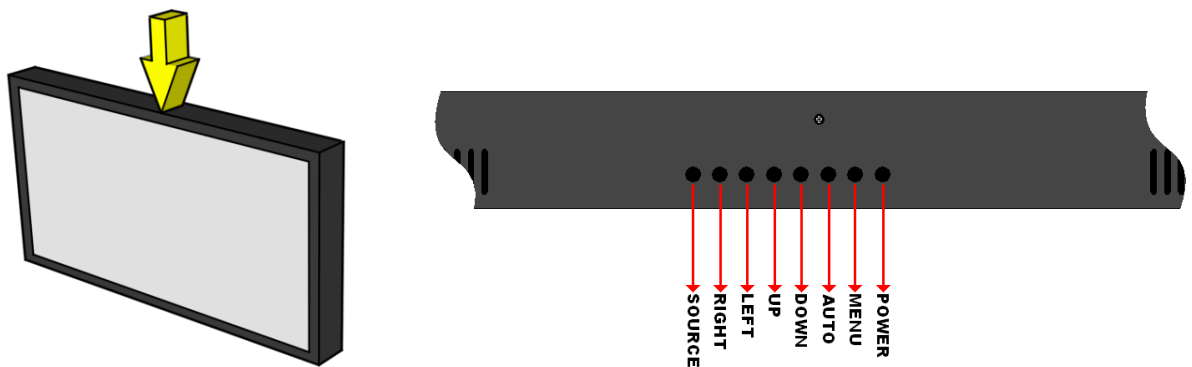

Located at the top (center) of the FD320CV VER HD are 8 buttons. Their functions are shown below:

BUTTON	FUNCTION	DESCRIPTION
1	Power	Toggles the power ON or Off. Also, wakes the display up from SLEEP mode.
2	Menu	Opens the MENU.
3	Auto	Auto-adjusts the display's size and position.
4	Down	Moves to the next selection in the menu.
5	Up	Moves to the previous selection in the menu.
6	Left	Decrease the selection's value in the menu.
7	Right	Increases the selection's value in the menu.
8	Source	Switches between sources coming into the display

Remote Control Buttons



BUTTON	DESCRIPTION
POWER	Toggles the power ON or OFF. Also, wakes the display up from SLEEP mode.
MENU	Opens the MENU.
DOWN	Moves to the next selection in the menu.
UP	Moves to the previous selection in the menu.
LEFT	Decrease the selection's value in the menu.
RIGHT	Increases the selection's value in the menu.
SOURCE	Switches between sources coming into the display.



Technical Drawing

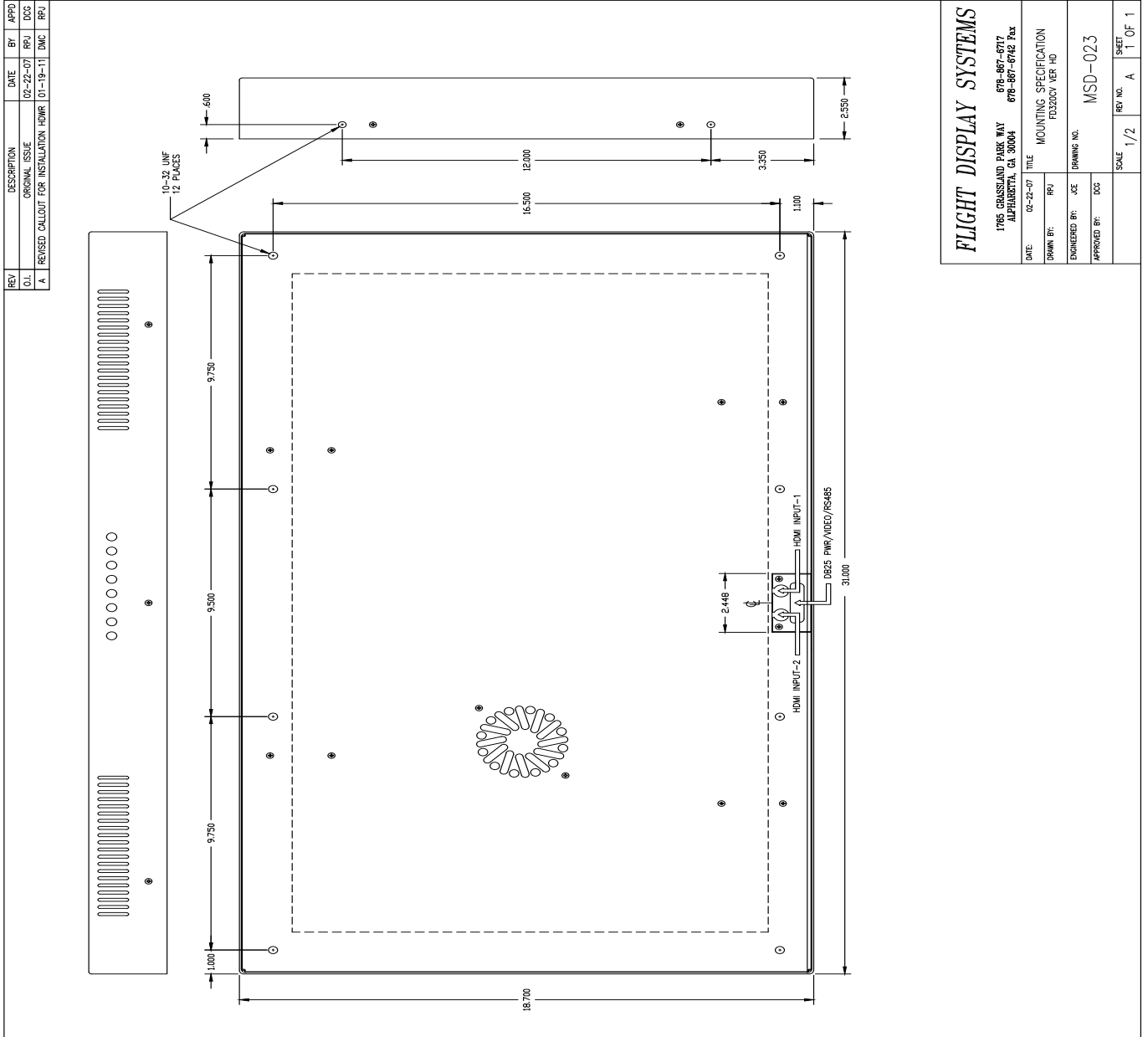



Technical Support

Should you have any questions concerning this product or other FDS Avionics Corp. products, please contact our Product Support representatives at 470-239-7421.

FDS Avionics Corp.
6435 Shiloh Road
Alpharetta, GA 30005
Phone: 470-239-7400
Fax: 470-239-7439
Email: sales@FDSAvionics.com

For further product information, technical data and sample wiring diagrams, please click on the Dealers section of our web site at www.FDSAvionics.com

Instructions for Continued Airworthiness

The FD320CV VER HD is designed not to require regular general maintenance.





Limited Warranty

All FDS Avionics Corp. products are warranted to be free from material or manufacturing defects for a period of 24 months from the date of shipment for General Aviation customers or 12 months from the date of shipment for Government/Special Mission customers. Any material or repair workmanship for in warranty repair service will be specifically warranted for 90 days or the remainder of the original warranty period, whichever is longer. If the original warranty period has expired, the 90-day repair warranty is limited to the material and workmanship specific to the repair activity completed.

The following conditions are exclusions to warranty coverage:

1. Labor costs associated with installation, removal or reinstallation of any product.
2. Damage to or malfunction caused by any unauthorized alteration made to the product.
3. Resolving signal quality issues caused by externally generated noise introduced by aircraft electrical systems or other components connected to any FDS product.
4. Any malfunction caused by improper installation or connection to aircraft wiring, industry standard cabin management/inflight entertainment systems, or third party commercial equipment not specifically identified as compatible with FDS products.
5. Any malfunction caused by installation that does not conform to precautions associated with operating environments listed in the operating manual or consistent with industry best practices such as high temperature, adequate ventilation, high humidity, high dust, or power surges.
6. Cosmetic damage or damage to internal components caused by installation or removal, failure to follow installation or operating instructions, or any neglect or misuse of the product.
7. Any product that is returned for service with a broken tamper evident seal, indicating tampering or improper handling of the product by an unauthorized person. Violation of product tamper evident seals or modification of factory installed serial and PMA labels voids any warranty, either expressed or implied.

The FDS Technical Support team is available to provide distance troubleshooting support during business hours (8:00am to 5:00pm EST) Monday through Friday at (470) 239-7421.

Many repair requests can be resolved through distance support and may not require return of merchandise to the factory. If a product must be returned to the factory for repair, an RMA number will be issued as directed by the Technical Support team and communicated by the Repair Coordinator.

Upon request by the customer, FDS may send a Service Technician onsite to repair any non-PMA products. The travel expenses incurred to include transportation, lodging and meals along with the technician's hourly rate shall be payable by the customer in accordance with FDS' applicable rates and procedures.

FDS Avionics Corp. will, upon receipt of returned merchandise, remanufacture or replace the unit at our discretion and return the product by Ground Return Shipping. Express return shipment will be the responsibility of the sender.

This warranty is not transferable.

Any implied warranties expire at the express limited warranty expiration date. FDS shall not be held liable for any indirect, special, punitive, incidental or consequential damages.

Some states do not allow limitation on the length of an implied warranty. In such states, the exclusions or limitations of this limited warranty may not apply.





Log of Revisions

Rev	Date	Page	Description
A	07/28/2008		Initial Release
B	08/11/2008	3,11	Updated weight, Changed remote control image & added chart
C	11/18/2008		Updated Installation Drawings, DB-9 Pin-outs, VGA wiring, Power & Ground wiring
D	01/29/2009	3,15	Updated specs, warranty info
E	03/27/2009	3	Updated Installation Instructions
F	04/02/2009	8	Updated DB-25 information
G	10/20/2010	12	Update Remote Control
H	01/06/2010	3	Amp Revise
I	03/23/2010	3	Current Rating Update
J	11/10/2010	9	Power Requirement Update, Format Change
K	01/21/2011		Updated Technical Drawing, Installation Instructions, added rear connector orientation, new VGA wiring, updated mounting holes
L	11/05/2012		Added pg.13 Command sets for controlling the monitors with serial numbers starting w/ 12xxxxxxx (10 digits) and above
M	05/23/2014		Address Change, Correction made onRS485 Command Set, new warranty
N	08/07/2017	ALL	New Format, New Company, New Branding, Updated VGA wiring diagram, Updated Warranty

